



Designers and Manufacturers of Hydraulic and Pneumatic Equipment Since 1953

## **SC HYDRAULIC ENGINEERING CORPORATION**

1130 Columbia Street - Brea, California 92821 - USA • Phone (714) 257-4800 - Fax (714) 257-4810

# **10 SERIES AIR OPERATED LIQUID PUMPS**

**P  
U  
M  
P  
S**





## *A "High Pressure" History...*

An innovator and pioneer in the field of hydraulic engineering, SC Hydraulic has been manufacturing air-driven liquid pumps for more than a half of a century.

Founded in 1953 by Bob Vedder and Willie Mohler, the company started with only a few core products. Basically air-driven liquid pumps. Today, SC Hydraulic's product line has expanded to include an extensive collection of air and gas boosters, power units, systems and selected high-pressure valves.



The product line remained stable through the 1980s seeing successful operation in an ever-increasing number of installations and applications, while sales grew through an expansion of distribution.

Under the leadership of Bob Vedder's daughter, Donna Perez, SC Hydraulic operates a state-of-the-art 65,000 square-foot facility in Brea, California, and is well prepared for future growth and innovation.

## *Where Hydraulic Force Meets Custom Engineering*

With products capable of achieving pressures exceeding 70,000 psig, SC Hydraulic Engineering Corp. is a force to be reckoned with in the field of hydraulic engineering.

SC Hydraulic manufactures a vast array of air-operated hydraulic pumps and boosters for a variety of industries. In addition to our current line of hydraulic products, we can work with you to custom design products to fit the exact specifications of your applications.

An international leader in hydraulic engineering, SC Hydraulic is staffed with educated and certified engineers. They are continually developing new products which are in sync with newly emerging applications, both in the United States and abroad.



*In a 65,000 square foot facility, SC Hydraulic is capable of setting the industry's highest standard while maintaining the best delivery times*

## *For Fluid Power...*

Contact SC Hydraulic today, to find out more about our capabilities or for a technical data sheet.



# PRESSURE RATIO OLD & NEW PART NUMBERS

In the mid 1990's with the advent of a new inventory and computer system, SC Hydraulic Engineering was forced to change the part numbering system for better control and understanding.

Prior to that time, a typical part number stated the basic series number, a ratio reference number, and a suffix if there were any modifications. Typically, a call out might be 10-500-1.5 or perhaps 10-600-20BA. The biggest change, and where some confusion may occur, is in the pressure ratio model call out for the various sizes available.

The chart below can be used as an aid in determining the correct number. Take careful note to similar call outs such as .5 (now 005) and 5 (now 050).

Additional changes of the part numbers from the old model numbers and the new numbers are shown on the 'How to Order Table'.

10-4 SERIES			10-5 & 10-5L SERIES			10-6 & 10-6L SERIES		
HYDRAULIC SECTION MODEL			HYDRAULIC SECTION MODEL			HYDRAULIC SECTION MODEL		
OLD	NEW	RATIO	OLD	NEW	D5 / RATIO	OLD	NEW	D6 / RATIO
0.25	003	5	0.24	003	5	.35QR	003	5
0.5	005	10	0.5	005	10	.5QR	005	10
1	010	15	0.65	007	12	1	010	20
1.5	015	30	1	010	20	1.5	015	25
2	020	35	1.5	015	25	2	020	35
3	030	55	1.75	018	30	3	030	55
5	050	100	2	020	35	5	050	95
8	080	140	3	030	55	8	080	145
12.5	125	220	4	040	70	10	100	180
			4.5	045	85	15	151	240
			6	060	105	20	201	330
			8	080	140	30	301	460
			10	100	195	40	402	740
			16	160	280			
			25	250	440			
			35	350	555			

# NO OTHER PUMPS OFFER ALL THESE ADVANTAGES

**Simple operating principle** – SC air operated hydraulic pumps operate on the simple but efficient principle of pressure intensification through the use of differential areas. Fulfilling Boyle's Law, a larger air-driven piston delivers pressure to a proportionally lesser diameter hydraulic piston, providing fluid flow at relatively higher pressures.

**High output capacity** and outstanding performance provided at very low cost.

**Guaranteed performance** – All SC Hydraulic pumps will give years of low cost, trouble free service when properly installed and maintained to manufacturer's instruction.

**Wide range of operating pressures** is provided by all models. For example, the D5000B55 operates efficiently when delivering from 400 to 5800 psi (see D5 Series specifications).

**Wide range of output capacities** – Only 100 psi air pressure is required for all models to attain maximum rate of flow (see performance charts for data).

**Complete flexibility** – SC Hydraulic pumps adapt to a wide variety of applications, from simple manual controls to fully automatic operation. Air motors are interchangeable for most models within each series.

**Automatic restart** – Whenever an SC Hydraulic pump is idle, the pilot valve is designed to re-position the pump on the power stroke for the next cycle of operation.

**Smooth operation** – The air piston actuating valve is precision fit to close tolerances for maximum efficiency and long service life.

**Both pressure and volume of flow** are easily and accurately controlled by a pressure regulator installed in the air supply line.

**Fluid Compatibility** – Pumps can operate with almost any type fluid service (specify when ordering).

**Hydraulic cylinders** are constructed from aluminum-bronze, stainless steel, or carbon steel.

**Hydraulic pistons** are constructed from stainless steel, hard chrome-plated.

**Materials incorporated** in the hydraulic assembly vary depending upon type of service and pump model.

**Designed for easy maintenance** – Costly down time is reduced to a minimum when service is required. "D" Dry Lube Series pumps are packed at the factory with valve lubricant and may be operated without a lubricator in air supply. Hydraulic cylinder packing may be replaced without dismantling the air motor.

**Three Series available** – choose from:

10-4 Series • 9 models • to 22,000 psi

10-5/10-5L Series • 16 models • to 55,000 psi

10-6/10-6L Series • 13 models • to 65,000 psi

**Applications include** static and burst testing, flow testing requiring relatively low flows at high pressures, operation of hydraulic presses, clamping, pressing, metal forming, piercing, blanking, staking, etc. Applications requiring extreme intermittent pressure and velocity commonly associated with water blasting and jetting.



# Liquid Pump Cut-a-way

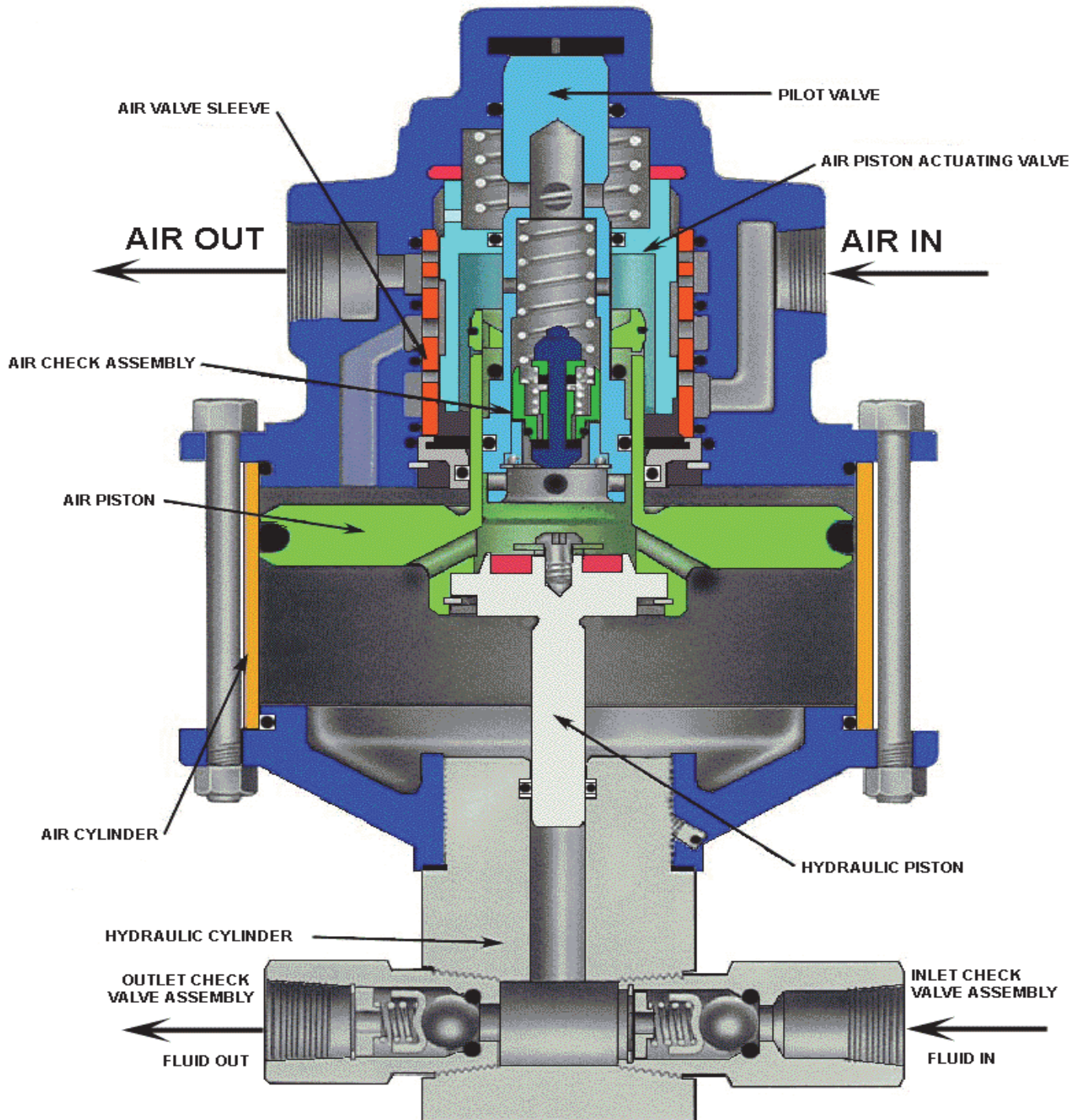

# 10-4 SERIES

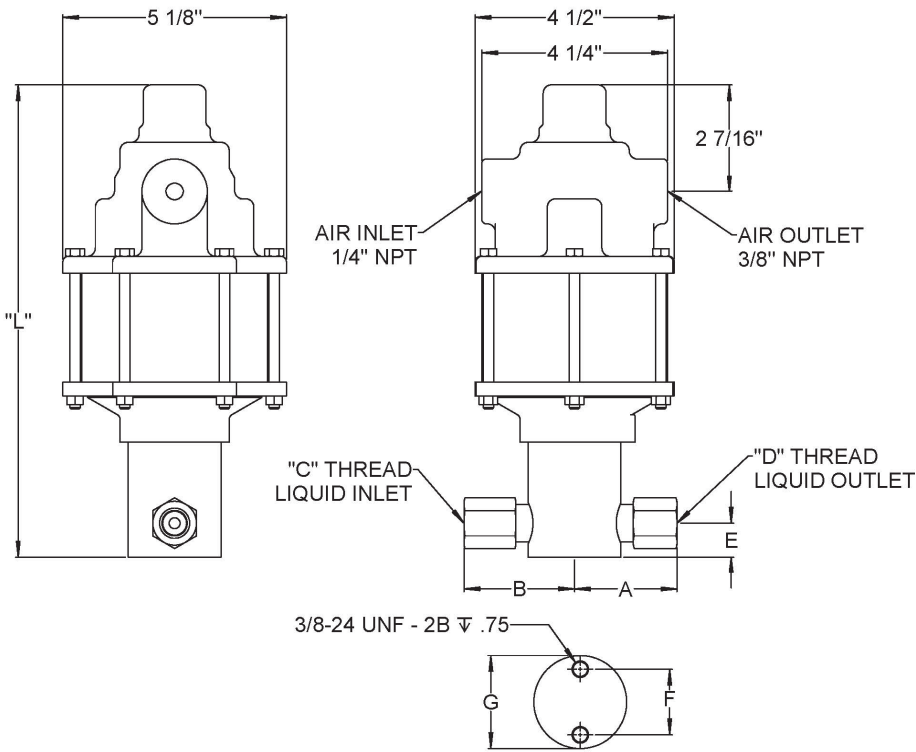

10-4 Series pumps have a 4" diameter air piston and a 1 1/4" stroke. Nine models are available with pressures up to 29,500 psig.

When operating from 0 to rated hydraulic pressure, air consumption will be approximately 14 scfm of free air at 100 psi output. At lower air pressures and higher hydraulic pressures, air consumption will be reduced proportionately to flow rates indicated.

Mounting may be in any position, vertical preferred. When mounting in an inverted position, a drain cock should be provided to drain off any liquid that may accumulate in the pilot valve air chamber.

## Mounting Dimensions in Inches

10-4 Series Model	L	A	B	NPT (Standard)		E	F	G
				C Thread	D Thread			
-003	11.375	2.438	3.000	1/2"	3/8"	.813	1.500	2.125
-005	11.188	2.438	3.000	1/2"	3/8"	.813	1.500	2.125
-010 thru -015	11.063	2.438	2.438	3/8"	3/8"	.813	1.500	2.125
-020 thru -030	10.063	2.438	2.438	3/8"	3/8"	.813	1.500	2.125
-050 thru -125	10.500	2.375	2.313	3/8"	3/8"	.813	1.500	2.125
-165	10.752	1.993	2.062	3/8"	9/16-18*	1.000	1.750	2.500

\*Coned and Threaded High Pressure Connection for 1/4" O.D. Tubing

## Measurements & Approximate Air to Hydraulic Pressure Ratios – Static Conditions

Pressure Ratio	10-4 Series Model	Hydraulic Piston Diameter (in)	Hydraulic Piston Area (in <sup>2</sup> )	Volume per Stroke (in <sup>3</sup> )	Air Pressure (PSI)									
					10	20	30	40	50	60	70	80	90	100
5	-003	1.6250	2.070	2.590	35	90	145	200	250	305	360	415	465	515
10	-005	1.1875	1.110	1.390	80	180	280	375	475	575	675	770	870	965
15	-010	0.8750	0.601	0.751	160	340	520	700	880	1060	1240	1440	1600	1800
30	-015	0.6875	0.371	0.464	250	550	850	1150	1425	1725	2000	2300	2575	2850
35	-020	0.6250	0.307	0.384	300	675	1050	1450	1800	2175	2525	2875	3225	3550
55	-030	0.5000	0.196	0.245	500	1040	1620	2200	2750	3340	3850	4475	5000	5550
100	-050	0.3750	0.110	0.138	950	1850	2900	3800	4850	5900	6875	7900	8900	9900
140	-080	0.3125	0.077	0.096	1300	2700	4150	5700	7100	8600	9900	11200	12600	14000
220	-125	0.2500	0.049	0.061	2100	4400	6750	8750	11250	13250	15250	17500	19750	22000
300	-165	0.2180	0.037	0.047	3400	6000	8500	12400	14600	17000	20900	23500	26900	29500

All pumps are recommended for intermittent duty.



# 10-4 SERIES

## APPROXIMATE RATE OF DISCHARGE

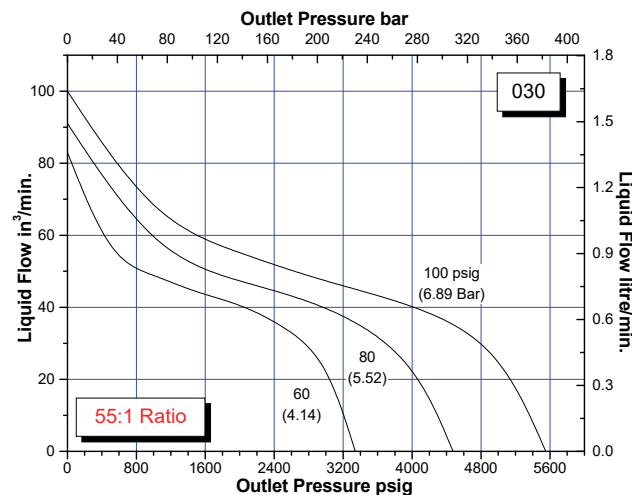
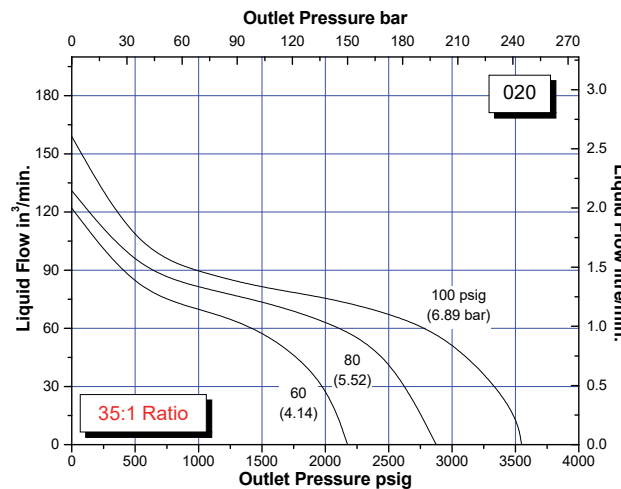
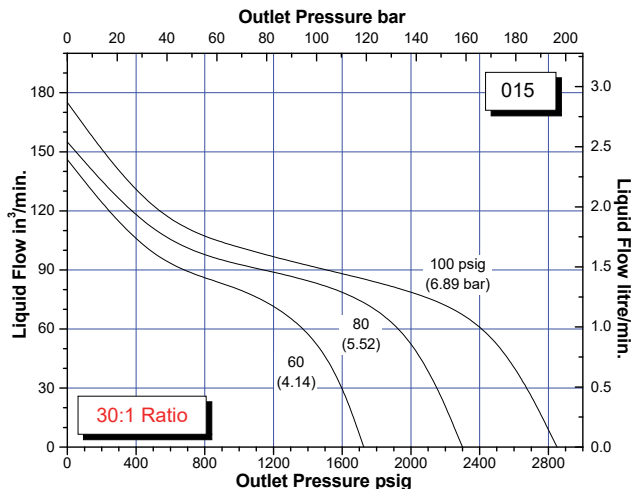
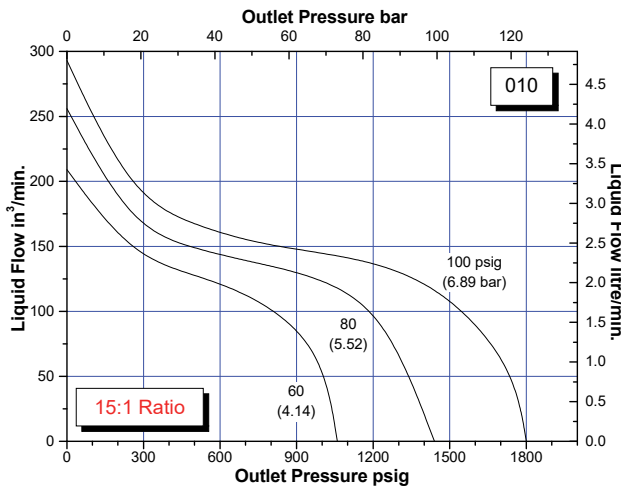
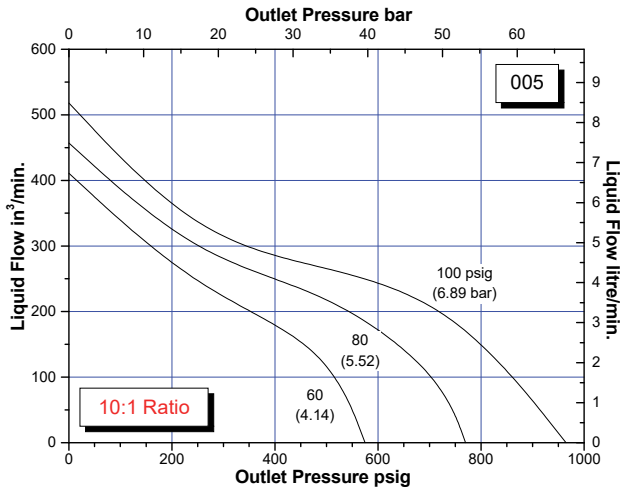
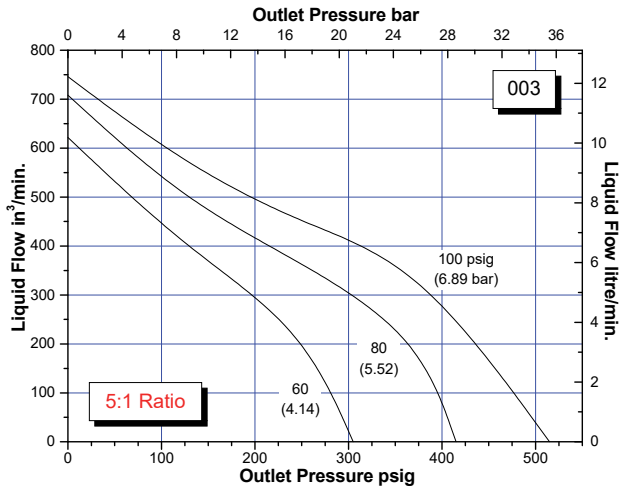

# 10-4 SERIES

## APPROXIMATE RATE OF DISCHARGE

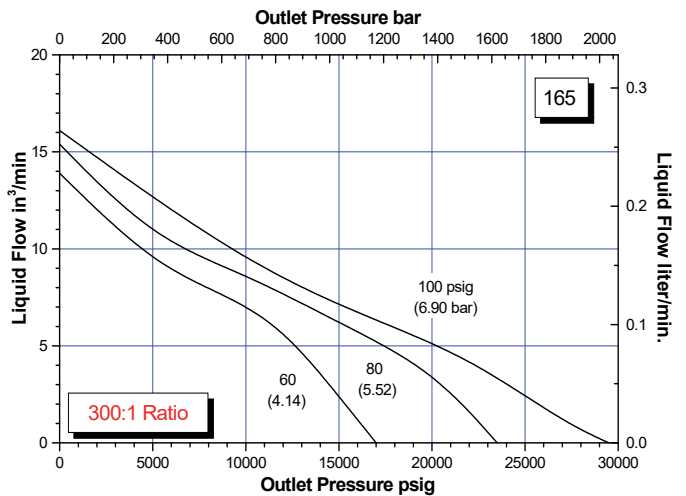
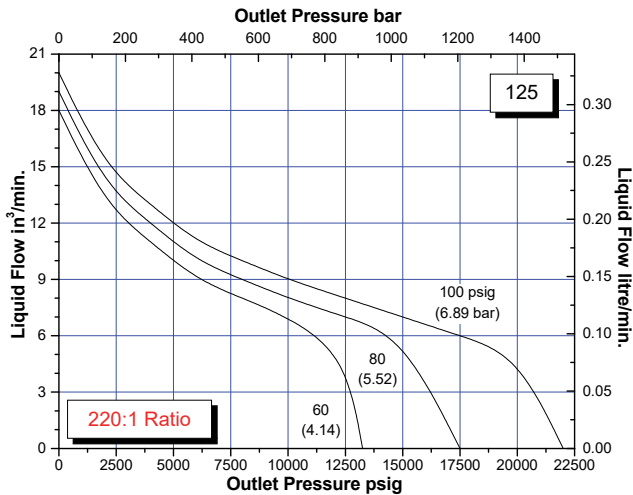
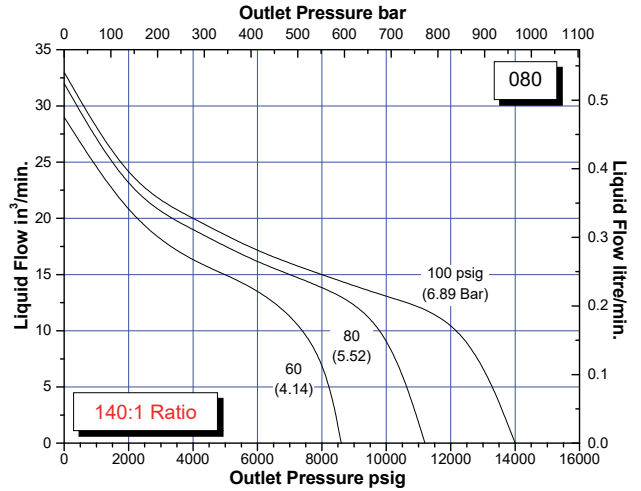
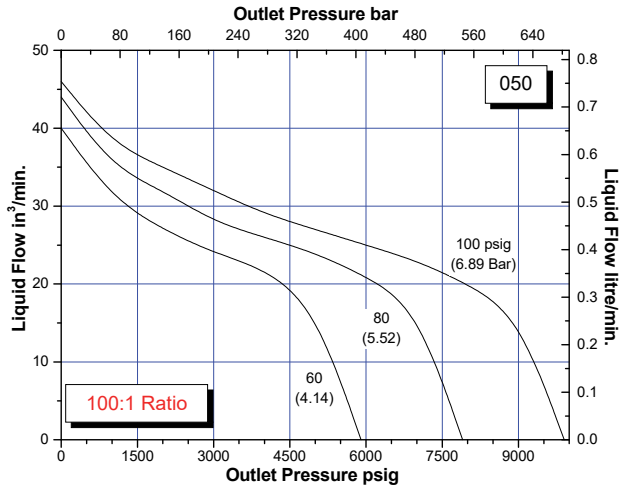

# 10-5 & 10-5L SERIES

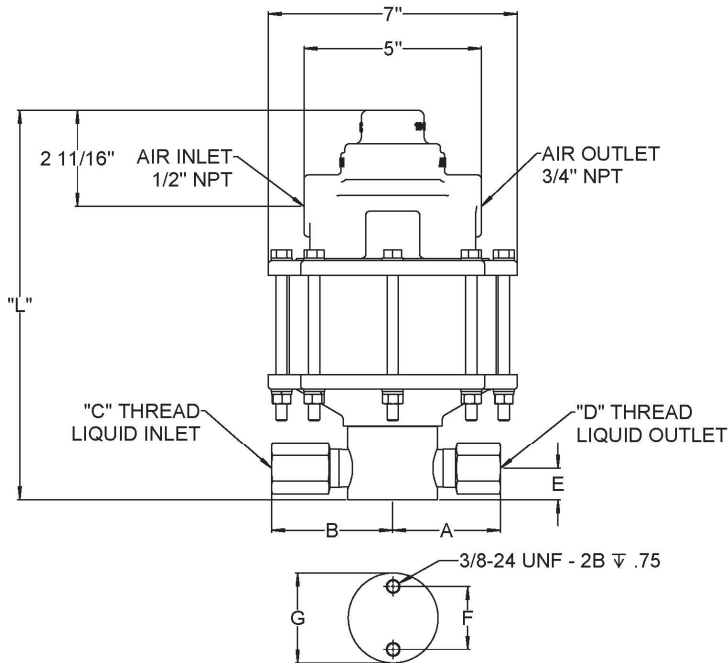

10-5 & 10-5L Series pumps have a 5 1/2" diameter air piston and a 1 1/4" stroke. Sixteen models are available with pressures up to 55,000 psig.

When operating from 0 to rated hydraulic pressure, air consumption will be approximately 28 scfm of free air at 100 psi output. At lower air pressures and higher hydraulic pressures air consumption will be reduced proportionately to flow rates indicated.

Mounting may be in any position, vertical preferred. When mounting in an inverted position, a drain cock should be provided to drain off any liquid that may accumulate in the pilot valve air chamber.

The 10-5 series "Non lube" and 10-5L series "Lube" pumps are identical except the 10-5 series is pre-lubricated at factory and therefore does not require a lubricator in the air drive supply line. The suffix "L" is added to the 10-5L series "Lube" pump part number to indicate a lubricator is required in the air drive supply line.

**Mounting Dimensions in Inches**

Pressure Ratio	10-5 & 10-5L Series Model	L	A	B	NPT/HF4 (Std)		SAE/HF4 (Optional)		E	F	G
					C Thread	D Thread	C Thread	D Thread			
5	-003	13.125	3.500	4.750	1"	1/2"	-	-10 SAE	1.125	2.375	3.125
10 thru 20	-005 thru -010	12.313	3.000	4.000	1"	1/2"	-	-10 SAE	1.000	1.750	2.500
25 thru 105	-015 thru -060	10.875	3.000	3.375	1/2"	1/2"	-10 SAE	-10 SAE	0.875	1.750	2.500
140 thru 440	-080 thru -250	11.250	2.500	2.313	3/8"	3/8"	-	9/16-18 *	0.875	1.750	2.500
555	-350	11.188	3.750	2.313	3/8"	9/16-18 *	-	-	.0875	1.750	2.500

\*Coned and Threaded High Pressure Connection for 1/4" O.D. Tubing

**Measurements & Approximate Air to Hydraulic Pressure Ratios – Static Conditions**

Pressure Ratio	10-5 & 10-5L Series Model	Hydraulic Piston Diameter (in)	Hydraulic Piston Area (in <sup>2</sup> )	Volume per Stroke (in <sup>3</sup> )	Air Pressure (PSI)									
					10	20	30	40	50	60	70	80	90	100
5	-003	2.3750	4.430	5.540	30	75	130	175	220	270	320	370	415	465
10	-005	1.6250	2.070	2.590	80	180	285	385	490	590	690	795	900	1000
12	-007	1.5000	1.770	2.210	90	200	340	450	560	700	850	980	1100	1225
20	-010	1.1875	1.110	1.390	145	330	525	700	925	1100	1300	1500	1700	1900
25	-015	1.0000	0.785	0.981	200	475	750	1000	1300	1550	1800	2000	2350	2625
30	-018	0.9375	0.689	0.861	225	525	875	1150	1500	1775	2050	2350	2700	3075
35	-020	0.8750	0.601	0.751	250	600	1000	1400	1775	2125	2475	2825	3200	3625
55	-030	0.6875	0.371	0.464	400	1000	1700	2200	2900	3400	4000	4600	5200	5800
70	-040	0.6250	0.307	0.384	500	1175	1950	2600	3350	4100	4900	5600	6350	7000
85	-045	0.5625	0.248	0.310	800	1700	2600	3400	4400	5100	6000	6900	7800	8600
105	-060	0.5000	0.196	0.245	900	2000	3150	4200	5400	6400	7450	8500	9700	10700
140	-080	0.4375	0.150	0.188	1100	2400	3900	5400	6900	8300	9800	11200	12600	14000
195	-100	0.3750	0.110	0.138	1400	3250	5250	7250	9250	11250	13250	15000	17000	18750
280	-160	0.3125	0.077	0.096	2250	4000	7750	10500	13500	16250	18750	21500	24500	27500
440**	-250**	0.2500	0.049	0.061	5000	8000	12500	16500	21000	25500	30000	34000	38000	42500
555**	-350**	0.2187	0.038	0.048	6250	12500	18750	25000	31250	37500	43750	47500	51250	55000

All pumps are recommended for intermittent duty.

\*\* Low duty intermittent operation recommended for pressures higher than 30,000-psi due to fatigue life limitation of materials of construction.

# 10-5 & 10-5L SERIES

## APPROXIMATE RATE OF DISCHARGE

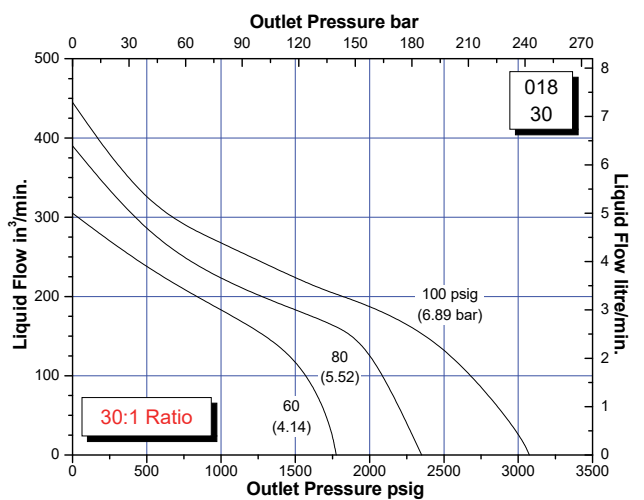
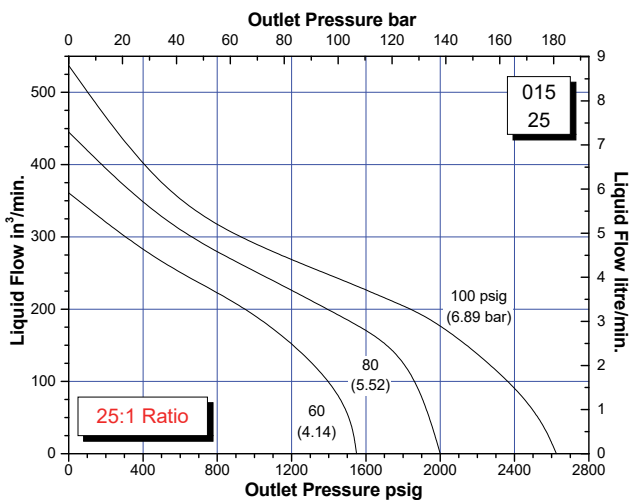
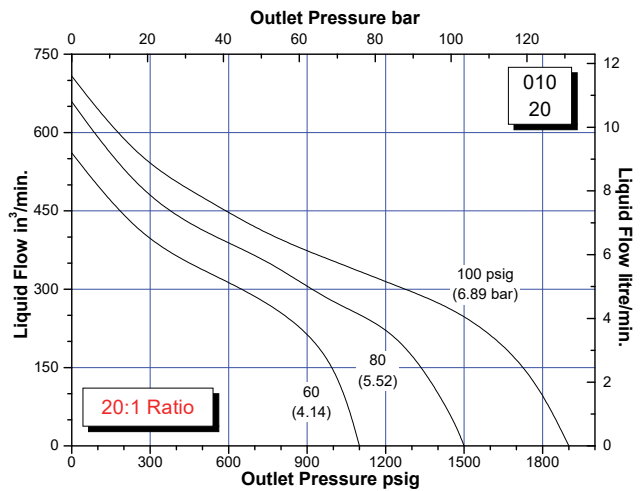
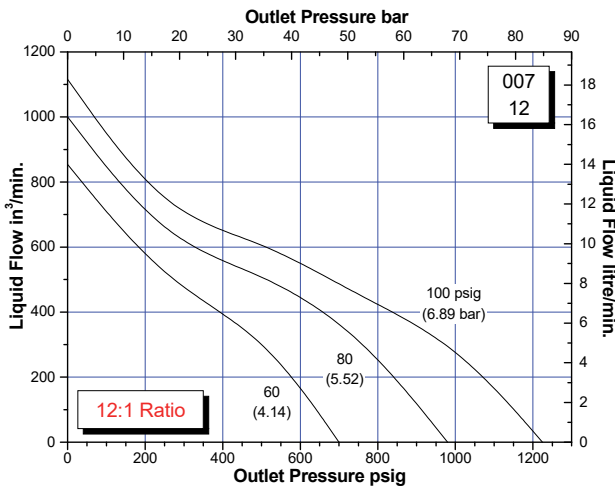
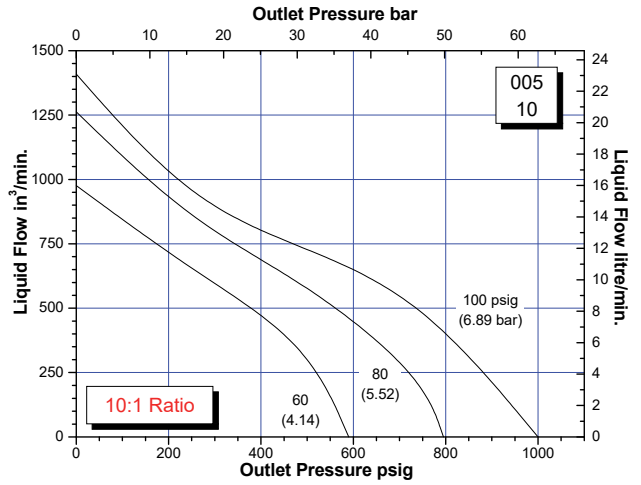
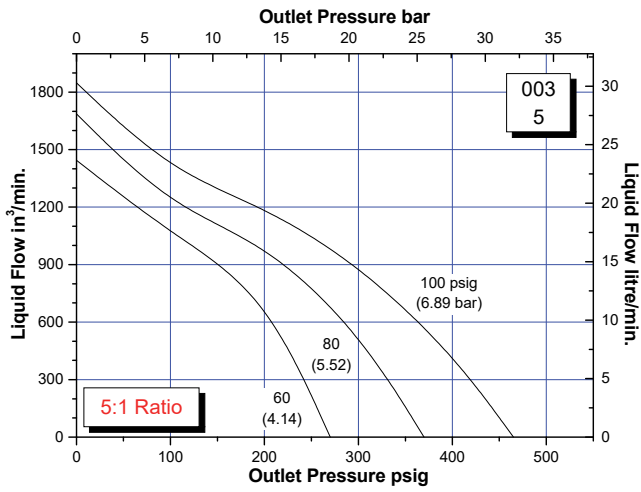

# 10-5 & 10-5L SERIES

## APPROXIMATE RATE OF DISCHARGE

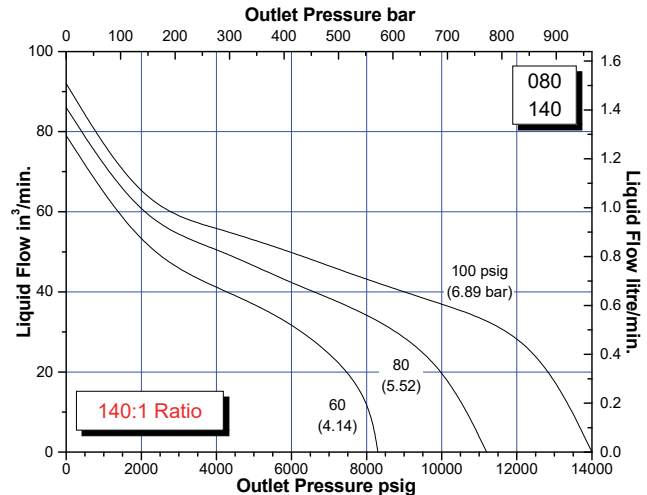
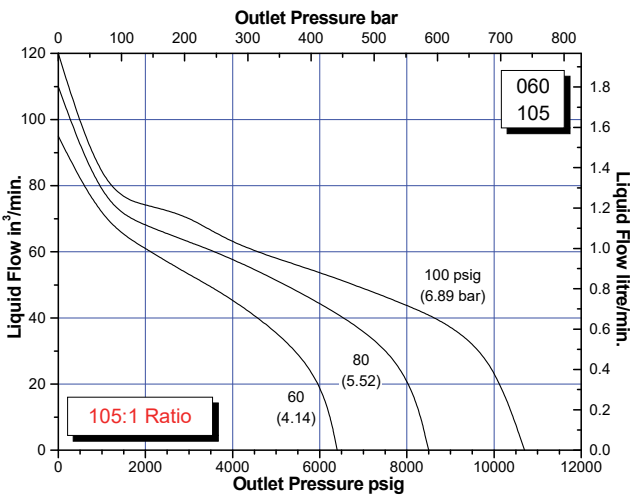
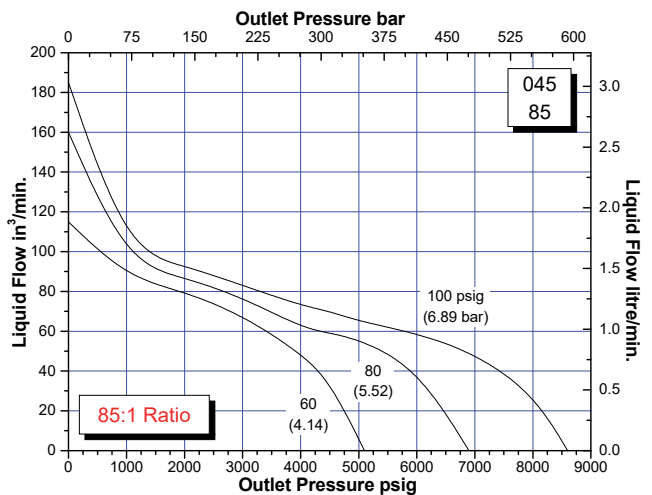
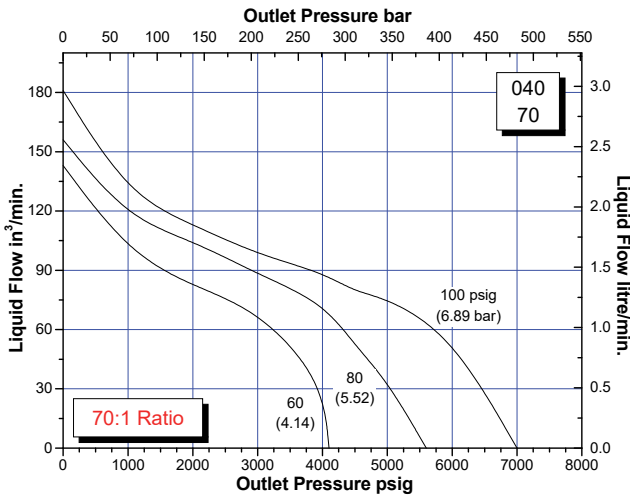
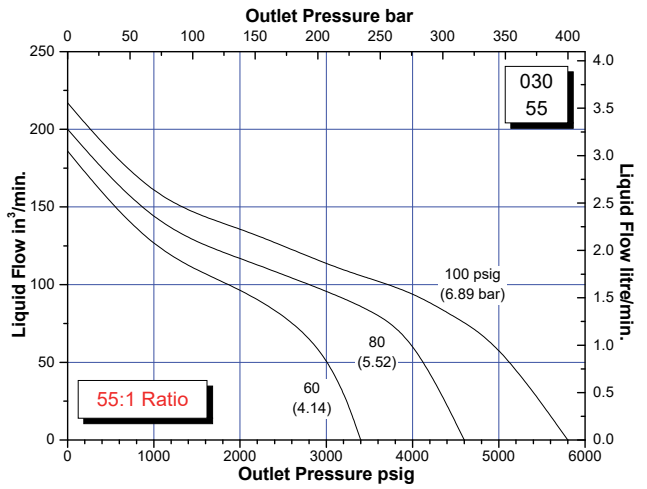
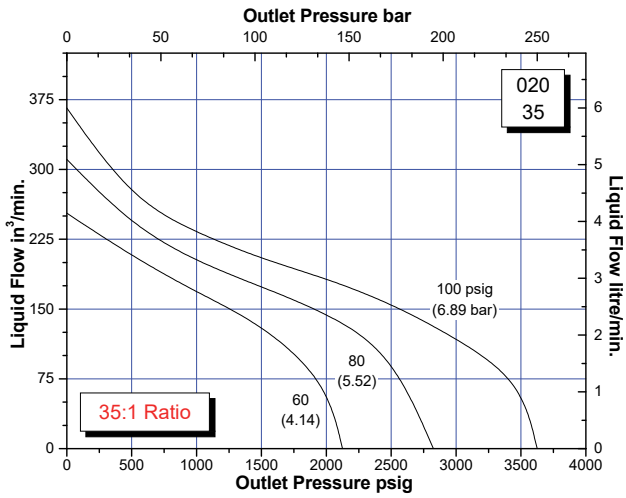

# 10-5 & 10-5L SERIES

## APPROXIMATE RATE OF DISCHARGE

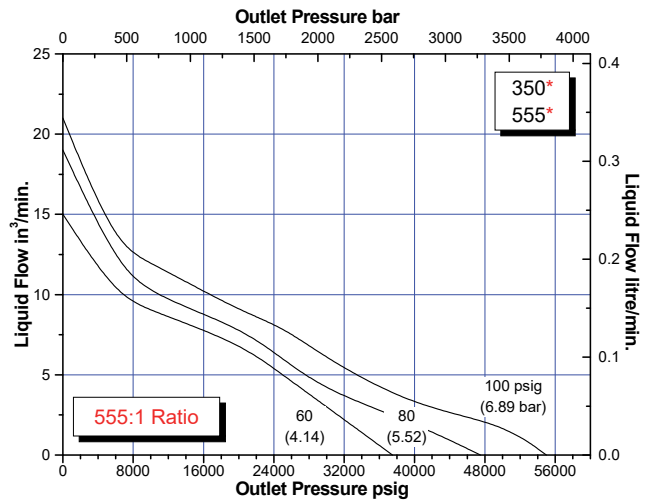
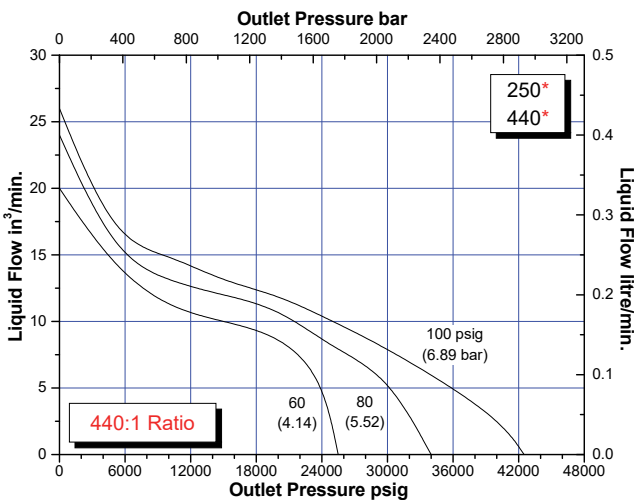
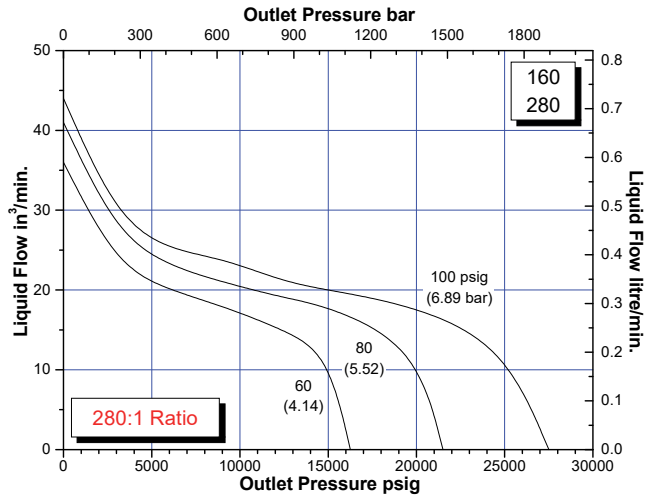
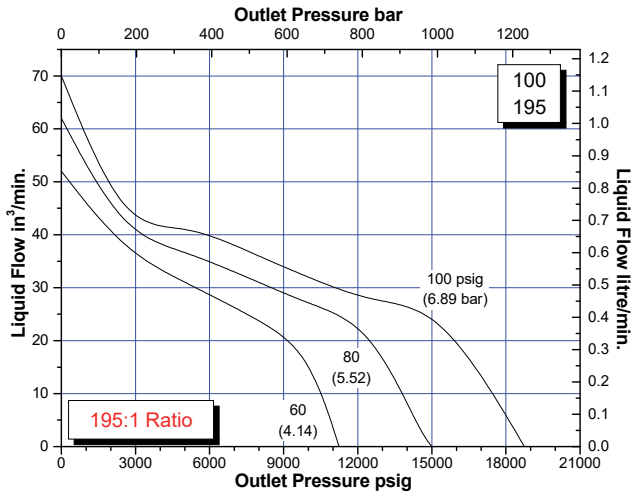

\*\* Low duty intermittent operation recommended for pressures higher than 30,000-psi due to fatigue life limitation of materials of construction. Consult factory for more information.



# 10-6 & 10-6L SERIES

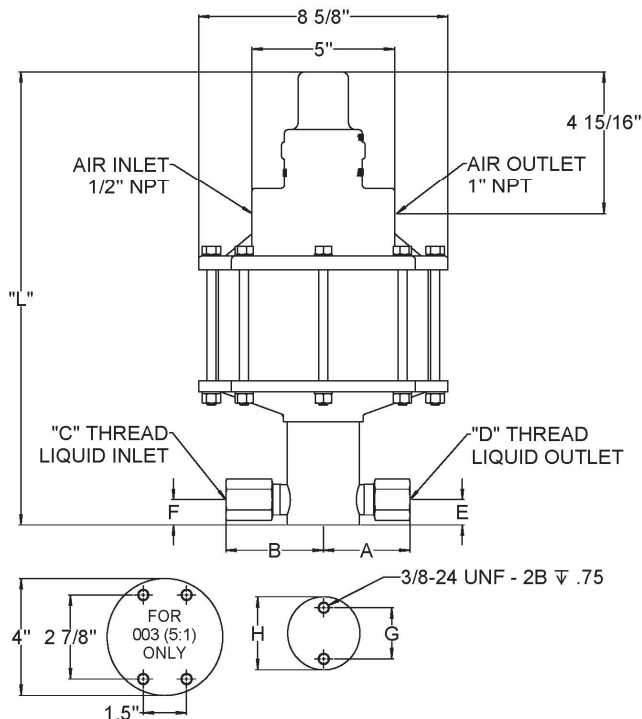

10-6 & 10-6L Series pumps have a 7" diameter air piston and a 2 1/2" stroke. Thirteen models are available with pressures up to 66,500 psig.

When operating from 0 to rated hydraulic pressure, air consumption will be approximately 56 scfm of free air at 100 psi output. At lower air pressures and higher hydraulic pressures air consumption will be reduced proportionately to flow rates indicated.

Mounting may be in any position, vertical preferred. When mounting in an inverted position, a drain cock should be provided to drain off any liquid that may accumulate in the pilot valve air chamber.

The 10-6 series "Non lube" and 10-6L series "Lube" pumps are identical except the 10-6 series is pre-lubricated at factory and therefore does not require a lubricator in the air drive supply line. The suffix "L" is added to the 10-6L series "Lube" pump part number to indicate a lubricator is required in the air drive supply line.

## Mounting Dimensions in Inches

Pressure Ratio	10-6 & 10-6L Series Model	L	A	B	NPT/HF4 (Std)		SAE/HF4 (Optional)		E	F	G	H
					C Thread	D Thread	C Thread	D Thread				
5	-003	19.625	4.875	2.375	1 1/4"	1"	-	-	1.500	2.500	---	4.000
10	-005	18.625	4.750	4.375	1"	1"	-	-	1.375	1.375	2.375	3.000
20 thru 35	-010 thru -020	17.063	3.000	4.000	1"	1/2"	-	-10 SAE	1.000	1.000	1.750	2.500
55 thru 180	-030 thru -100	15.750	3.000	3.375	1/2"	1/2"	-10 SAE	-10 SAE	0.875	0.875	1.750	2.500
240 thru 330	-151 thru -201	16.000	2.500	2.313	3/8"	3/8"	-	9/16-18 *	0.875	0.875	1.750	2.500
460	-301	16.000	3.750	2.313	3/8"	9/16-18 *	-	-	0.875	0.875	1.750	2.500
740	-402	16.250	4.250	2.313	3/8"	9/16-18 *	-	-	1.125	1.125	2.375	3.000

\*Coned and Threaded High Pressure Connection for 1/4" O.D. Tubing

## Measurements & Approximate Air to Hydraulic Pressure Ratios – Static Conditions

Pressure Ratio	10-6 & 10-6L Series Model	Hydraulic Piston Diameter (in)	Hydraulic Piston Area (in <sup>2</sup> )	Volume per Stroke (in <sup>3</sup> )	Air Pressure (PSI)									
					10	20	30	40	50	60	70	80	90	100
5	003	3.000	7.070	17.70	50	100	150	200	250	300	350	400	450	500
10	005	2.125	3.560	8.900	85	185	285	390	490	590	690	795	900	1000
20	010	1.438	1.620	4.050	165	425	650	875	1075	1300	1550	1750	1950	2150
25	015	1.315	1.350	3.380	180	450	725	1000	1300	1550	1850	2125	2400	2700
35	020	1.125	0.994	2.490	250	625	1025	1400	1800	2150	2500	2850	3250	3600
55	030	0.875	0.601	1.500	450	1050	1700	2275	2900	3500	4100	4650	5200	6000
95	050	0.688	0.371	0.928	750	1750	2800	3700	4750	5900	6875	7700	8750	9700
145	080	0.563	0.249	0.623	1100	2600	4200	5550	7100	8500	10000	11500	12950	14400
180	100	0.500	0.196	0.490	1500	3200	5200	7100	9000	10800	12500	14500	16300	18000
240	151	0.438	0.150	0.375	1900	4400	6900	9100	11600	14000	16400	18800	21300	23700
330 **	201 **	0.375	0.110	0.275	3000	6000	9500	12600	16000	19100	22300	25600	29000	32300
460 **	301 **	0.313	0.077	0.193	4000	8800	13700	18000	22500	27000	31500	36500	41400	45800
740 **	402 **	0.250	0.049	0.123	8000	15000	23000	29700	37200	45000	52500	59200	66500	***

All pumps are recommended for intermittent duty.

\*\* Low duty intermittent operation recommended for pressures higher than 30,000-psi due to fatigue life limitation of materials of construction.

\*\*\* 10-6\_402 pump maximum air drive pressure is 90-psi, maximum outlet pressure is 66,500-psi.

# 10-6 & 10-6L SERIES

## APPROXIMATE RATE OF DISCHARGE

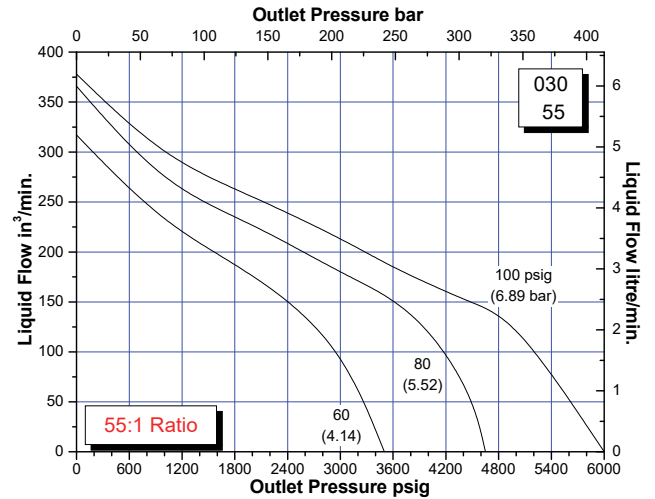
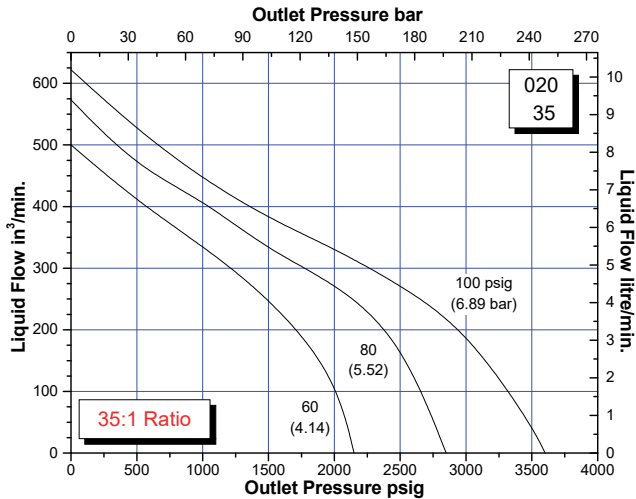
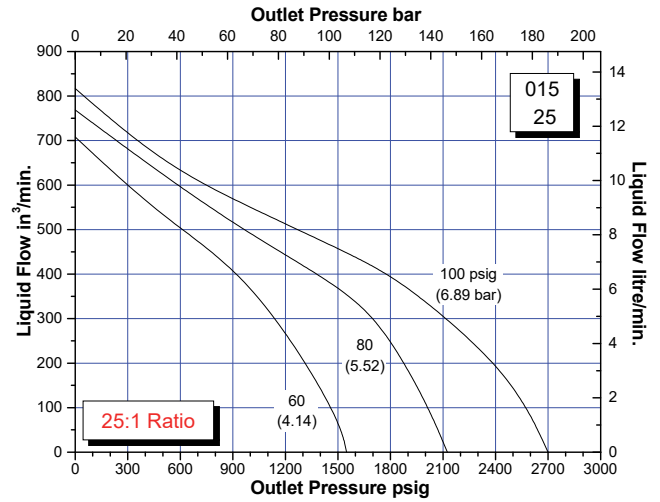
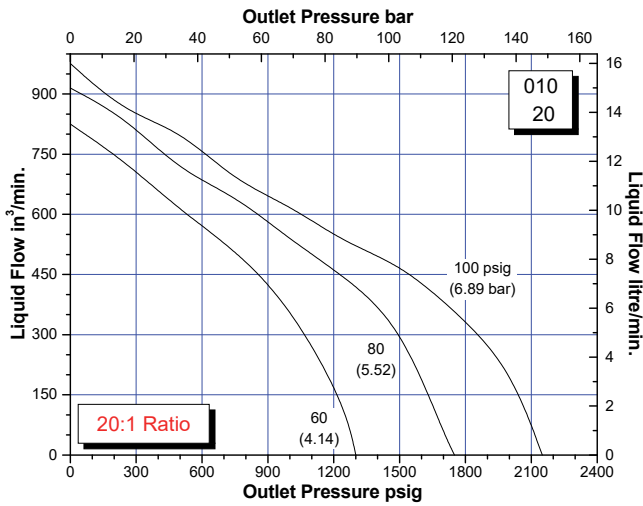
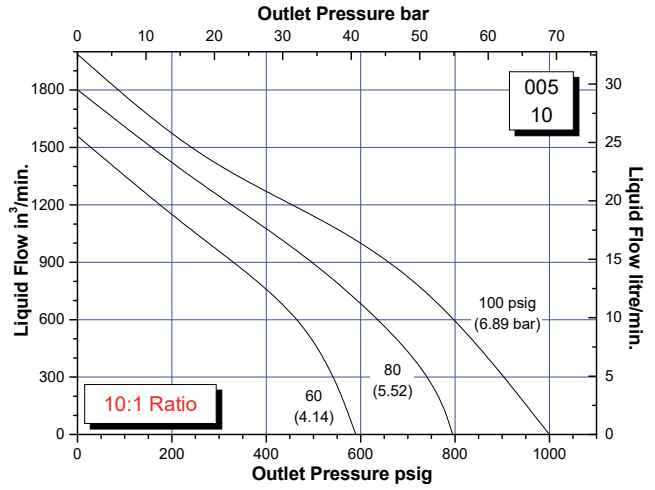
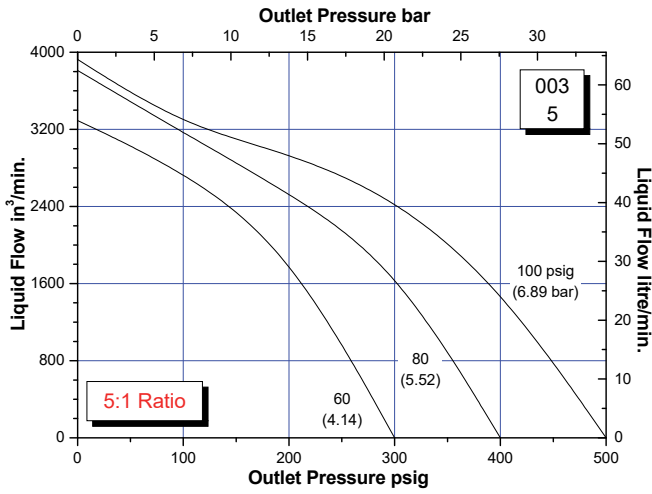

# 10-6 & 10-6L SERIES

## APPROXIMATE RATE OF DISCHARGE

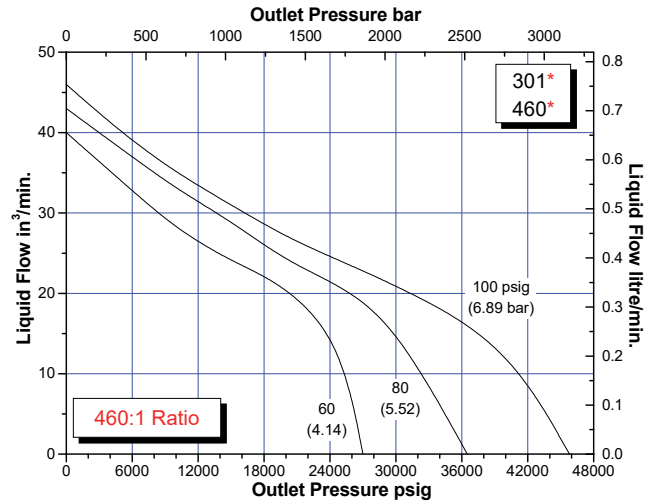
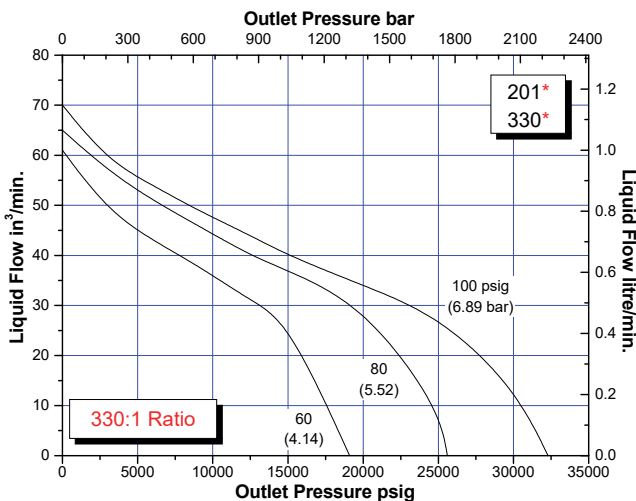
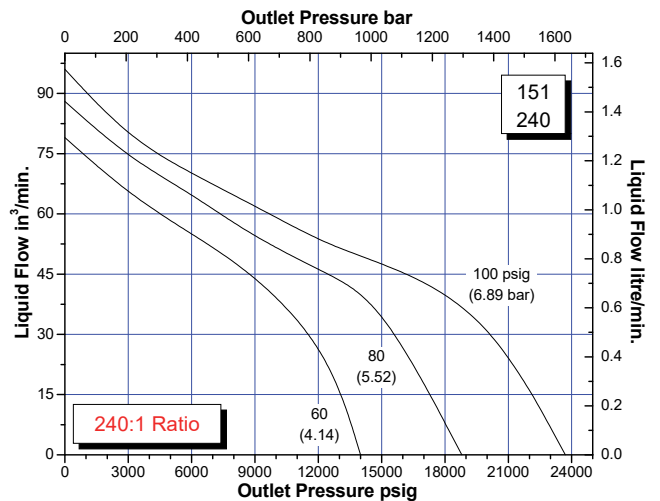
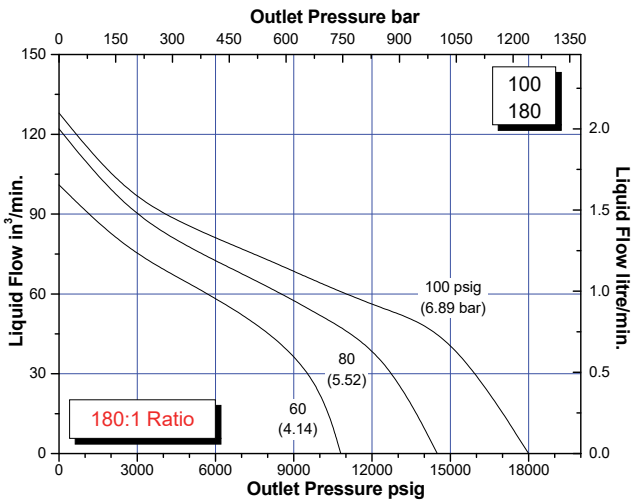
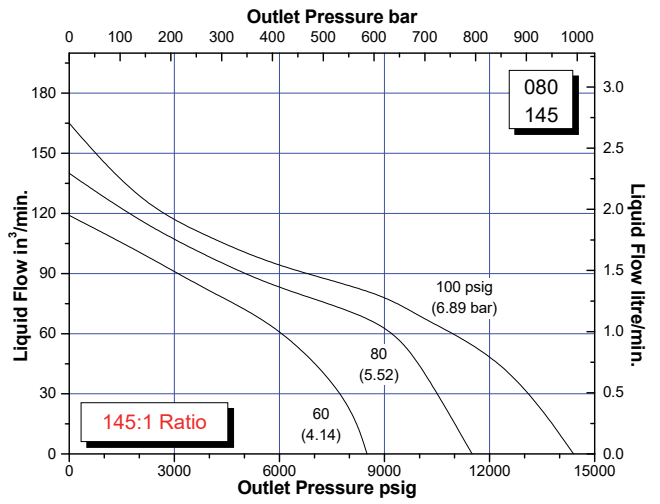
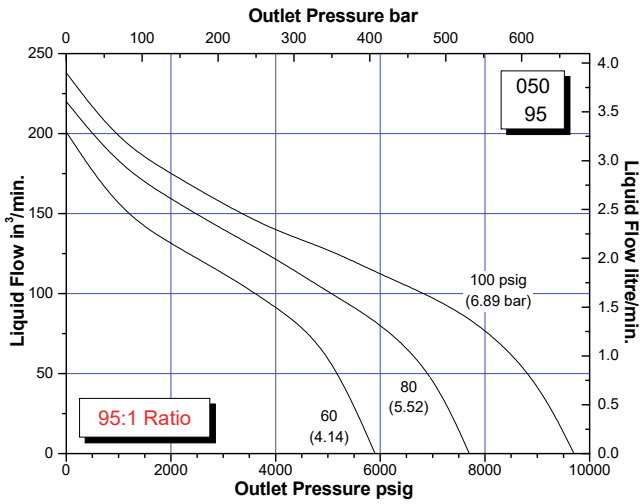

# 10-6 & 10-6L SERIES

## APPROXIMATE RATE OF DISCHARGE

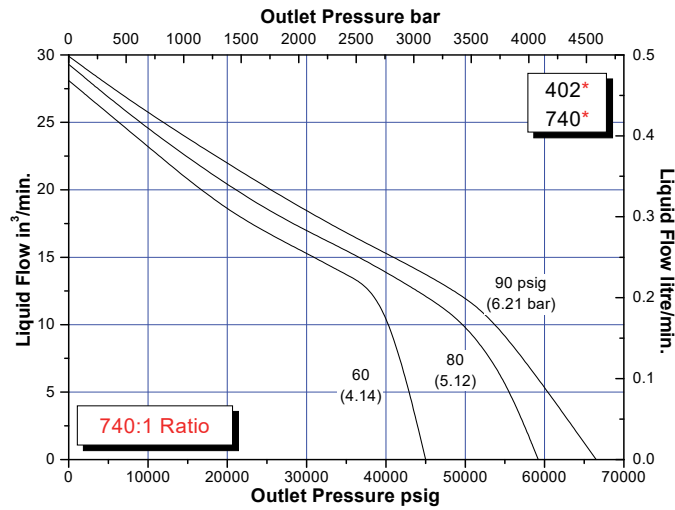

\*\* Low duty intermittent operation recommended for pressures higher than 30,000-psi due to fatigue life limitation of materials of construction. Consult factory for more information.

# 80-5 & 80-6 SERIES INTENSIFIERS

SC Hydraulic Engineering 80-5 and 80-6 Intensifiers operate on the same principle as our air operated liquid pumps with one distinctive difference — the air motor is modified so that it operates as a double-acting cylinder. Instead of automatically reciprocating until the stall pressure is reached, the 80 Series Intensifiers require an external four-way air valve to operate the unit.

POSITION ROD INDICATOR		
MODEL	"A" RETRACT	"B" EXTEND
80-5	1.188	3.937
80-6	2.362	3.987

The end caps have 1/4" NPT air supply port connections and the unit can be supplied with a position indicator rod at the top of the intensifier if required. All ratios and options available on the intensifiers are the same as on our 10-5/10-5L and 10-6/10-6L Series pumps. The units can be mounted in any position however upright is preferred. The air cylinder does not require lubrication.

Refer to the "How to Order" and performance data sheets of the 10-5/10-5L and 10-6/10-6L Series pumps for additional information.

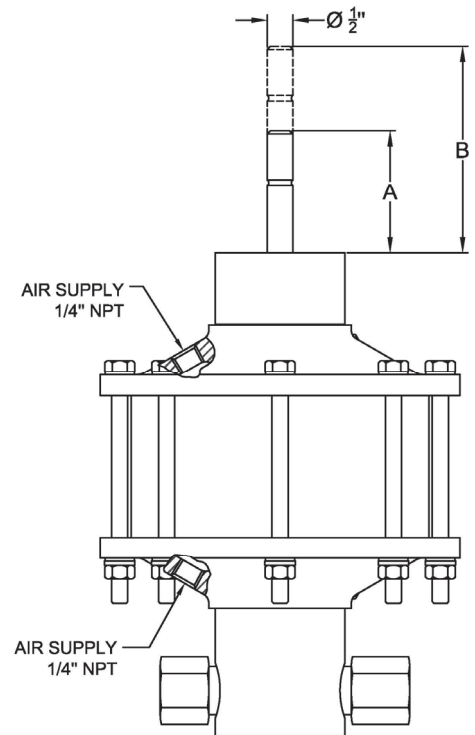

# 10-5/10-5L & 10-6/10-6L SERIES MOUNTING BRACKETS

MOUNTING BRACKET DIMENSIONS						
Pump Series	Part No.	W	H	A	B	C
10-5/10-5L	11-5216S000	6.75	6.83	5.50	5.89	4.77
10-6/10-6L	11-6172S000	6.75	7.94	5.50	7.00	5.88

Mounting brackets can be ordered with a pump by adding an "M105" modification as a suffix on the model number for the 10-5/10-5L or 10-6/10-6L pumps. If ordered as separate parts use the numbers above. One or two brackets can be used for each pump depending on the application.

The brackets are installed by removing the three bolts for the bracket position and loosening the remaining tie rod bolts. The tie rod bolts should then be drawn up gradually in a cross sequence for uniform tightening to 15-17 ft-lb. Refer to the "Servicing Instructions" for additional information.

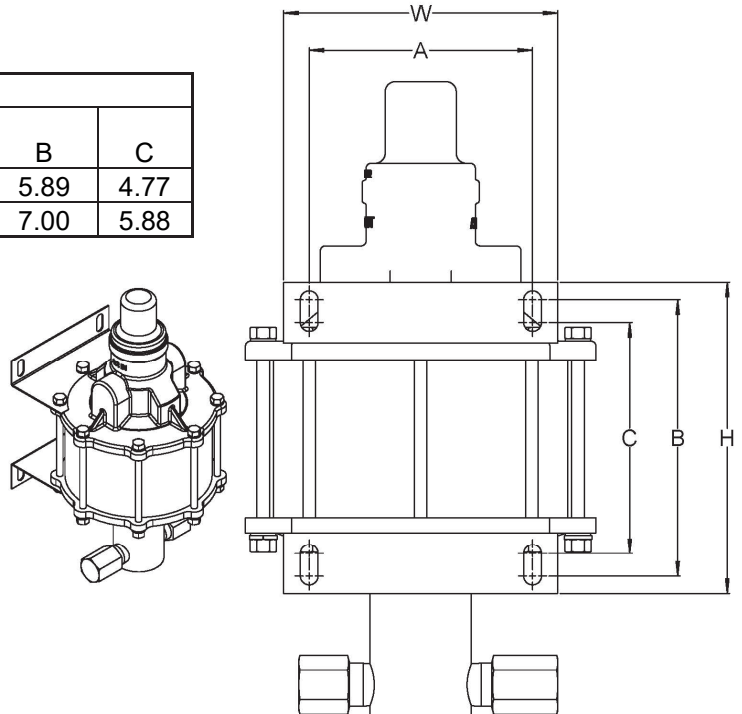

# PUMP MODIFICATIONS

A combination of any of the modifications shown can be supplied upon request. Consult factory for additional information and dimensional data if required.

**“A” Modification** – Available on all models

This modification utilizes dual seals in the hydraulic assembly with a bleed-off between the seals to atmosphere, thus providing a visual indication of hydraulic seal leakage. Used where contamination of the air motor from the hydraulic fluid being pumped is objectionable

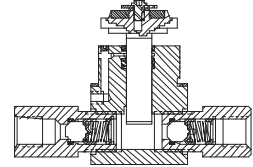

**“B” Modification** – Available on 10-5/10-5L and 10-6/10-6L

The “B” Models have a bottom inlet connection for convenient tank top installation or alternate mounting configuration.

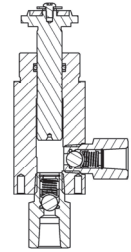

**“C” Modification** – Available on 10-5/10-5L and 10-6/10-6L

The “C” Models utilize PTFE chevron packing in the hydraulic assembly for ultimate performance when other packing material is not compatible with the fluid used or because of extreme temperature conditions. The “A” modification is included on all “C” models and the check valves have PTFE O-rings.

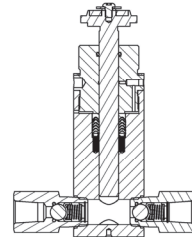

**“H” Modification** – Available on 10-5/10-5L and 10-6/10-6L

The “H” Models utilize special packing in the hydraulic assembly for maximum performance where hydraulic fluid media is contaminated with foreign matter, thus providing for a much greater life expectancy from the hydraulic seals than with standard O-ring seals. The “A” modification is included on all “H” models and the check valves have PTFE O-rings.

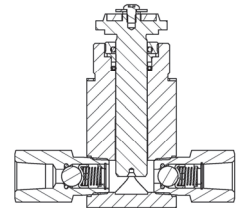

**“R” Modification** – Available on 10-5/10-5L and 10-6/10-6L.

The “R” Models are furnished with an isolator attachment which prevents the hydraulic piston retracting into the air motor during operation, thus providing for 100% non-contamination of the hydraulic assembly from the air motor. The isolator also acts as a heat barrier.

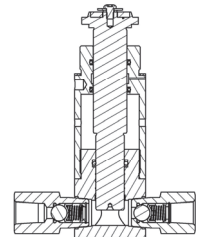



# HOW TO ORDER TABLE

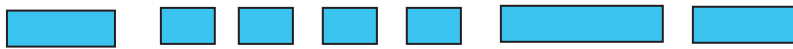
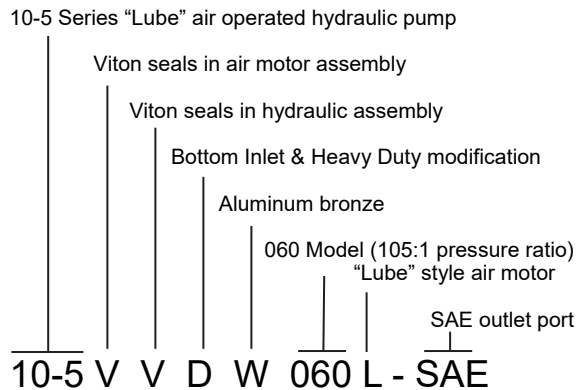

Table Reference →

1 2 3 4 5 6 7

## Example #1 Pump Selection



## Example #2 Pump Selection

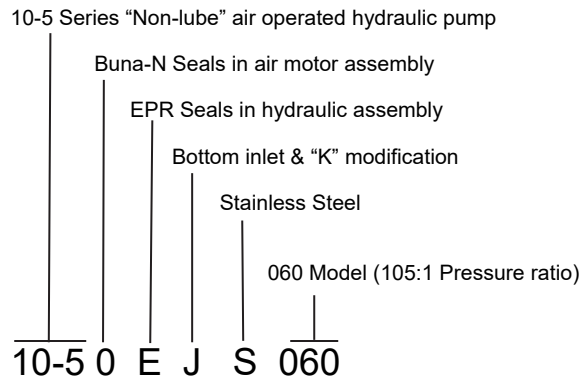

**TABLE 1 Pump Series Designation**

<b>10-4</b>	Series "Lube" pump
<b>10-5_L</b>	Series "Lube" pump <sup>(3)</sup>
<b>10-5</b>	Series "Non-lube" pump
<b>10-6_L</b>	Series "Lube" pump <sup>(3)</sup>
<b>10-6</b>	Series "Non-lube" pump
<b>80-5</b>	5 1/2" Bore intensifier
<b>83-5</b>	5 1/2" Bore intensifier with position indicator rod
<b>80-6</b>	7" Bore intensifier
<b>83-6</b>	7" Bore intensifier with position indicator rod

**TABLE 2 Seal Compound – Air Motor**

<b>0</b>	Buna-N (Nitrile) - Standard
<b>V</b>	Viton (Fluorocarbon)

**TABLE 3 Seal Compound – Hydraulic Section**

<b>0</b>	Buna-N (Nitrile) - Standard
<b>E</b>	EPR (Ethylene Propylene)
<b>V</b>	Viton (Fluorocarbon)
<b>*</b>	Consult factory for special compounds

**TABLE 4 Modifications**

<b>0</b>	Standard pump
<b>A</b>	"A" modification
<b>B</b>	Bottom inlet <sup>(1)</sup>
<b>C</b>	Chevron seals
<b>D</b>	Bottom inlet & heavy duty <sup>(1,2)</sup>
<b>E</b>	Bottom inlet & "A" modification <sup>(1)</sup>
<b>F</b>	Isolator & Chevron seals <sup>(1,2)</sup>
<b>G</b>	Isolator & heavy duty <sup>(1,2)</sup>
<b>H</b>	Heavy duty <sup>(1)</sup>
<b>J</b>	Bottom inlet & "K" modification <sup>(1)</sup>
<b>K</b>	"K" modification <sup>(1)</sup>
<b>M</b>	Bottom inlet, "A" & "K" modification <sup>(1)</sup>

**TABLE 4 Modifications (continued)**

<b>N</b>	Isolator & "A" modification <sup>(1)</sup>
<b>P</b>	Isolator & "K" modification <sup>(1)</sup>
<b>Q</b>	Isolator, "A" & "K" modification <sup>(1)</sup>
<b>R</b>	Isolator <sup>(1)</sup>
<b>S</b>	Heavy duty & "K" modification <sup>(1,2)</sup>
<b>U</b>	Heavy duty, bottom inlet & "K" modification <sup>(1,2)</sup>
<b>V</b>	Heavy duty, isolator & "K" modification <sup>(1,2)</sup>

**TABLE 5 Materials of Construction – Hydraulic Section**

<b>W</b>	Aluminum bronze & stainless steel - Standard
<b>S</b>	All stainless steel

**TABLE 6 Model Designation – Pressure Ratio**

Refer to "Measurements & Approximate Air to Hydraulic Pressure Ratios" table on page 6, 9 & 13

**TABLE 7 Port Options**

<b>Blank</b>	Standard
<b>SAE</b>	Straight thread as indicated on page 6, 9 & 13
<b>HF4</b>	9/16"-18 thread, 1/4" OD tube, rated for 60,000 psi

**Additional special modifications may be included with an "M" suffix at the end of the model number. Consult with factory.**

**Notes:**

- (1) Not available for 10-4 Series.
- (2) "A" modification included with all Chevron and Heavy Duty seal modifications.
- (3) Add letter "L" after model designation number in Table 6. Refer to example #1.



## LIMITED WARRANTY

**SC** manufactured products are warranted free of original defects in material and workmanship for a period of one year from date of purchase to first user. This warranty does not include packing, seals or failures caused by lack of proper maintenance, incompatible fluids, foreign materials in the air media, in the fluid media or application of pressures beyond catalog ratings. Products believed to be originally defective may be returned, freight prepaid, for repair and/or replacement to the distributor, authorized service representative or to the factory. If upon inspection by the factory or authorized service representative and the problem is found to be originally defective material or workmanship, repair or replacement will be made at no charge for labor and materials, F.O.B. the point of repair or replacement. Permission to return under warranty should be requested prior to shipment. A Return Material Authorization Number (RMA), the original purchase date, purchase order number, serial number, model number, reason for return or other pertinent data to establish warranty claim must be included in the documentation to expedite the return or replacement to the owner.

If the unit has been disassembled, misused, or altered without prior **written** authorization, warranty is void. If it has been improperly reassembled or substitute parts have been used in place of factory manufactured parts, warranty is void.

Any modification to any SC product which you have made or may make in the future will void warranty. SC disclaims any and all liability obligation, or responsibility for the modified product, and for any claims, demands or causes of action for damage or for personal injuries resulting from the modification and/or use of such a modified SC product.

**SC's obligation with respect to its products shall be limited to replacement, and in no event shall SC be liable for any loss or damage, consequential or special, of whatever kind or nature, or any other expense which may arise in connection with or as a result of such products or the use or incorporation thereof in a job. This warranty is expressly made in lieu of all other warranties of merchantability and fitness for a particular purpose. No express warranty and no implied warranties whether of merchantability or fitness for a particular purpose or otherwise, other than those expressly set forth above, shall apply to SC products.**

Other catalogs available from SC Hydraulic Engineering. Contact your local distributor or us direct and request the ones(s) you need by name or number. Catalogs are also available online at [www.schydraulic.com](http://www.schydraulic.com).



**Catalog # D15001**

**L3 Series Air Operated Liquid Pumps**

Compact sized pumps for pressures up to 15,600 psi plus three styles of power units.

**Catalog # D15002**

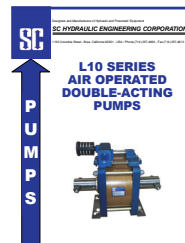

**L10 SERIES AIR OPERATED LIQUID PUMPS**

10" Air drive double-acting pump for pressures up to 30,000 psi.



**Catalog # D15004**

**AIR BOOSTERS & SYSTEMS**

Compact and double-acting up to 5:1 ratio plus booster systems with reservoirs and air controls.

**Catalog # D15005**

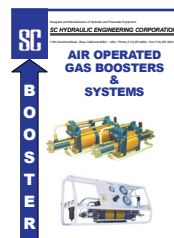

**AIR OPERATED GAS BOOSTERS**

Single and double-acting and two stage boosters up to 25,000 psi plus complete gas booster systems.

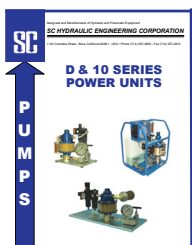

**Catalog # D15007**

**10 SERIES POWER UNITS**

Six different types with and without reservoirs and pressures up to 65,000 psi. All non-electric.

**Catalog # D15006**



**FLOW CONTROL & AIR PILOT SWITCH VALVES**

High pressure check, sequence, release, relief, and air pilot switch valves for liquid and gas applications.

Distributed by: